

GENERAL NOTES:

THIS DRAWING ILLUSTRATES THE PERCEIVED ORIGINAL DESIGN INTENT OF THE DOOR TYPE NOTED BELOW, AND IS TO BE REFERENCED ONLY AS A GUIDE IN PREPARATION OF FABRICATION DRAWINGS FOR DOOR REPLACEMENT. VERIFICATION OF ALL EXISTING SITE CONDITIONS, DIMENSIONS AND APPLICABLE CODES IS THE RESPONSIBILITY OF THE FABRICATOR, INSTALLER OR OWNER. ALL PERFORMANCE CRITERIA AND OPERATIONAL CHARACTERISTICS ARE TO BE DETERMINED BY THE OWNER. THIS DRAWING IS NOT FOR CONSTRUCTION.

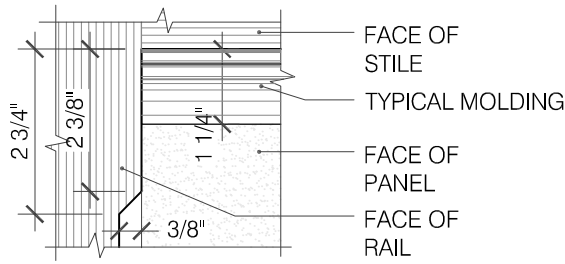

TYP. ENLARGED CORNER DETAIL

SCALE: 3" = 1'-0"

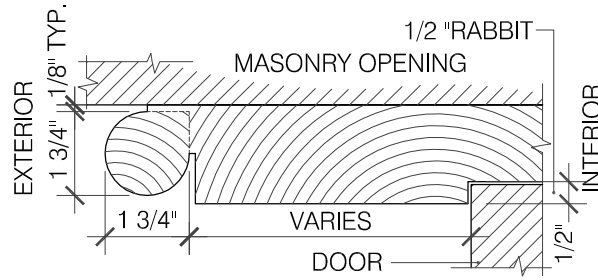

5 SECTION AT BRICK MOLD AND JAMB

SCALE: 3" = 1'-0"

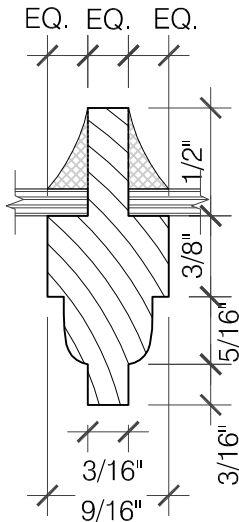

6 GLASS STOP DETAIL

SCALE: 1'-0" = 1'-0"

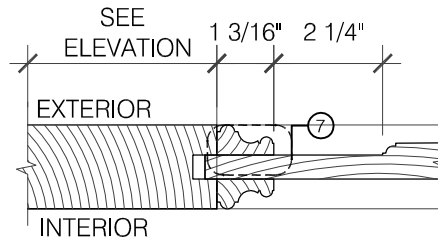

4 SECTION AT RAIL AND PANEL

SCALE: 3" = 1'-0"

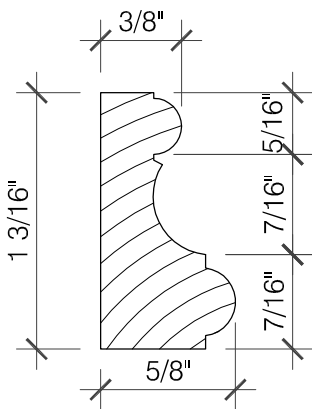

7 PANEL STOP DETAIL

SCALE: 1'-0" = 1'-0"

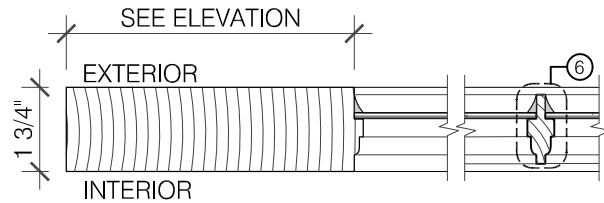

3 SECTION AT STILE/RAIL AND GLASS

SCALE: 3" = 1'-0"

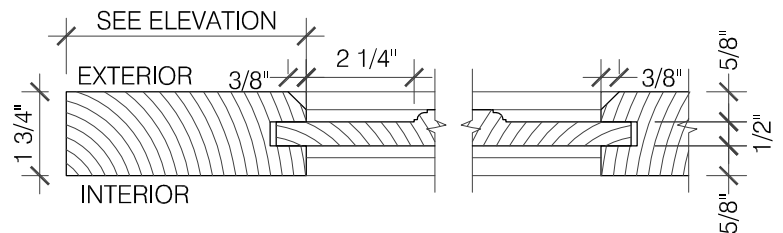

2 SECTION AT STILE AND PANEL

SCALE: 3" = 1'-0"

GENERAL NOTES:

THIS DRAWING ILLUSTRATES THE PERCEIVED ORIGINAL DESIGN INTENT OF THE DOOR TYPE NOTED BELOW, AND IS TO BE REFERENCED ONLY AS A GUIDE IN PREPARATION OF FABRICATION DRAWINGS FOR DOOR REPLACEMENT. VERIFICATION OF ALL EXISTING SITE CONDITIONS, DIMENSIONS AND APPLICABLE CODES IS THE RESPONSIBILITY OF THE FABRICATOR, INSTALLER OR OWNER. ALL PERFORMANCE CRITERIA AND OPERATIONAL CHARACTERISTICS ARE TO BE DETERMINED BY THE OWNER. THIS DRAWING IS NOT FOR CONSTRUCTION.